

Parts List			
ITEM	QTY	PART NUMBER	DESCRIPTION
1	1	075CXM	Machined 3/4" Coupler X 3/4" Hose Barb
2	1	75G	COUPLING GASKET
3	2	75K	1" CAM ARM W/ RING
4	2	75P	CAM ARM PIN
5	1	100DECAL	Mini Coupling Decal

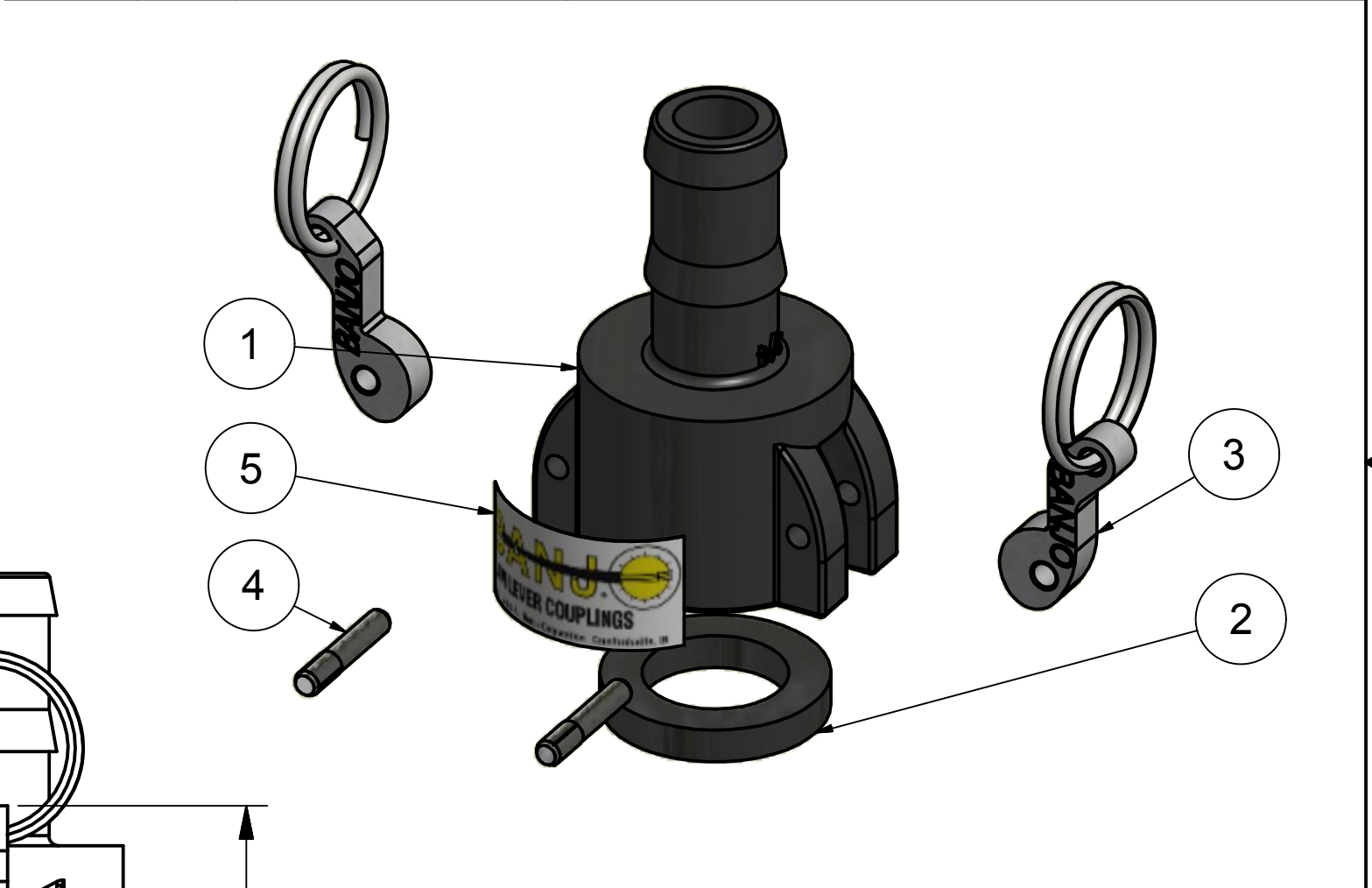
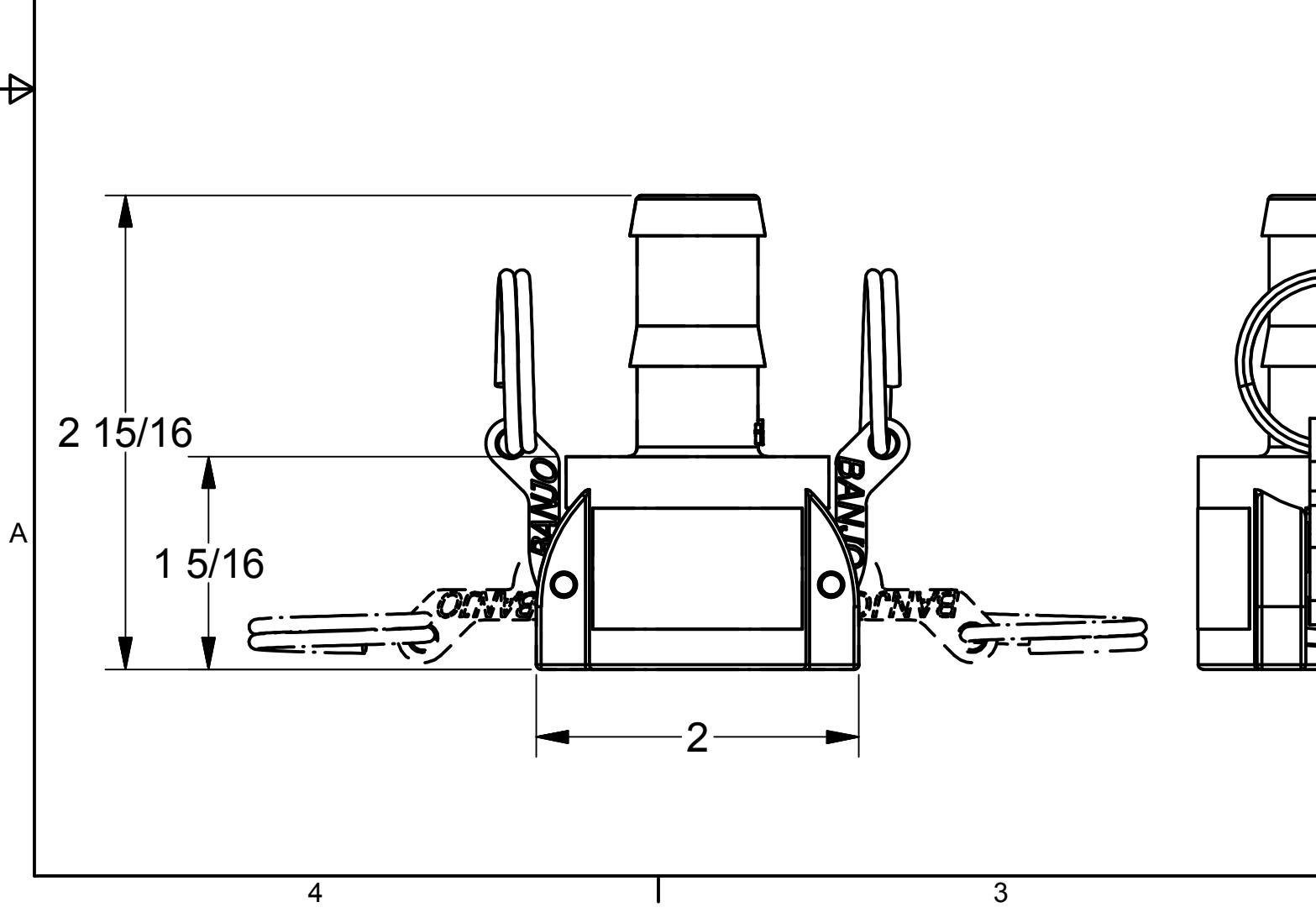

THIS DRAWING AND ALL INFORMATION CONTAINED THEREON ARE THE EXCLUSIVE PROPERTY OF BANJO CORPORATION.

UNLESS SPECIFICALLY NOTED, THIS DRAWING AND ITEMS SHOWN ON THIS DRAWING ARE SUBJECT TO CHANGE AT ANY TIME.

BANJO CORPORATION

BANJO CORPORATION
 150 BANJO DRIVE, CRAWFORDSVILLE, IN 47933
 WEB SITE: WWW.BANJOCORP.COM
 E-MAIL: BANJOSALES@IDEXCORP.COM

DESCRIPTION
 3/4" COUPLER X 3/4" HOSE BARB

PART NUMBER
 075C