

CAST IRON SELF-PRIMING CENTRIFUGAL PUMPS

INSTRUCTION MANUAL

2" 222 SERIES
3" 333 SERIES
4" 444 SERIES

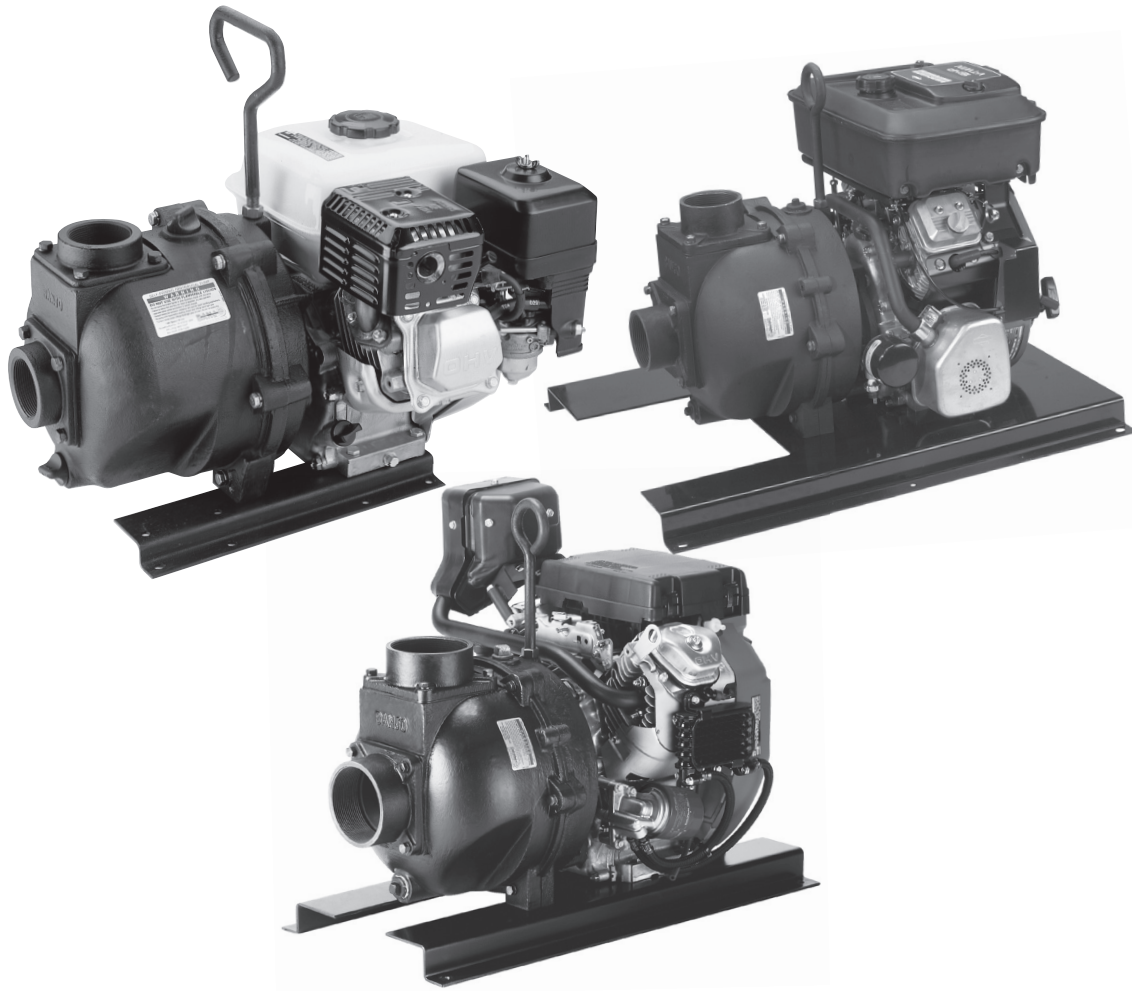

BANJO CORPORATION | A Unit of IDEX Corporation
150 Banjo Drive, Crawfordsville, IN 47933 U.S.A.
banjocorp.com | Telephone: (765) 362-7367

OVERVIEW

Read these instructions and the instructions covering operation of the pump drive unit.

The gas engine (if so equipped) is shipped with no oil. Consult your owners manual for specific oil recommendations, maintenance procedures, schedules, and troubleshooting. The maximum angle of operation for gas engine drive units is 25° in all directions. For engine warranty service contact your local engine dealer.

Make certain that all hose and pipe connections are airtight. An air leak in the suction line may prevent priming and will reduce the performance of the pump.

Do not restrict the pump inlet. High volume pumps such as the Banjo 444 Series pumps should not have the inlet port or line restricted. If the pump is equipped from the factory with a 4" inlet flange, the pump should be plumbed with a 4" inlet line. If the pump is equipped from the factory with a 3" inlet flange, the pump should be plumbed with a 3" inlet line. If the pump is equipped from the factory with a 2" inlet flange, the pump should be plumbed with a 2" inlet line. Failure to follow these instructions can result in pump cavitation and pump failure.

Always place the pump as close to the liquid to be pumped as possible. Keep the suction line short and with few bends. Keep the pump and engine on a level foundation. A poor foundation and a heavy suction hose (made heavier when "primed" full of liquid) could result in a pump "down the hole". It is not necessary to drain the pump body after use, unless there is a danger of freezing.

There are no points on the pump that need lubrication. The pump seal is cooled and lubricated by the fluid being pumped. When pumping dirty water or liquids containing solids, always use a basket strainer on the end of the suction line.

Engine warranty service available at authorized Honda & Briggs and Stratton Dealers.

*Note: Do NOT operate pump without the supplied EPA approved fuel tank and lines.

WARNINGS



OPERATION WARNING

Do not operate the gas engine (if so equipped) until you have put oil in the engine. Do not run the pump dry. Serious damage to the mechanical seal or complete failure of the mechanical seal can result from running the pump dry. Always fill the pump with water or the liquid being pumped before starting the drive unit.



WARNING! DO NOT USE WITH FLAMMABLE LIQUIDS.

Do not use flammable liquids. This pump is not designed or produced to pump flammable liquids of any kind. Failure to follow this warning can result in explosion, serious bodily injury or death.



STORAGE WARNING

There are important instructions regarding the preparation of the engine for long periods without use (reference the engine owners manual). Before long periods of storage, the pump should be flushed with clean water and drained. Leave all plugs (fill and drain) out of the pump. Always store the pump in a heated and dry building.

PERFORMANCE

2" CAST IRON PUMPS

Port Size

Suction..... 2" NPT

Discharge 2" NPT

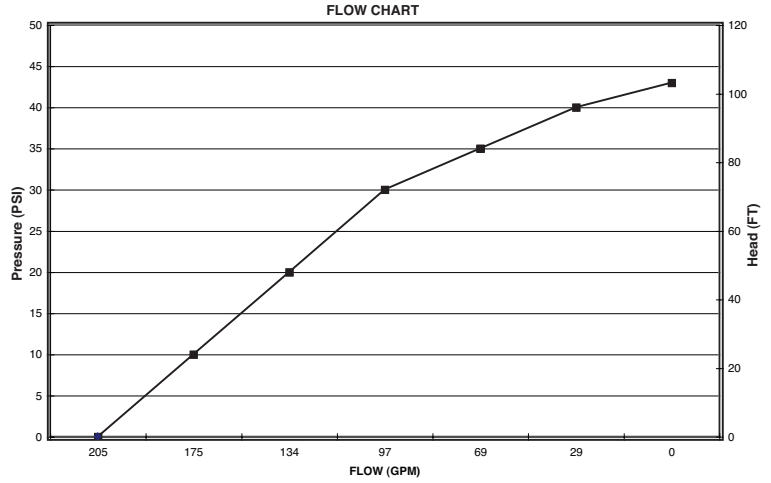

FLOW CHART FOR 222PIH5, 222PI6PRO & 222PBI

3" CAST IRON PUMPS

Port Size

Suction..... 3" NPT

Discharge 3" NPT

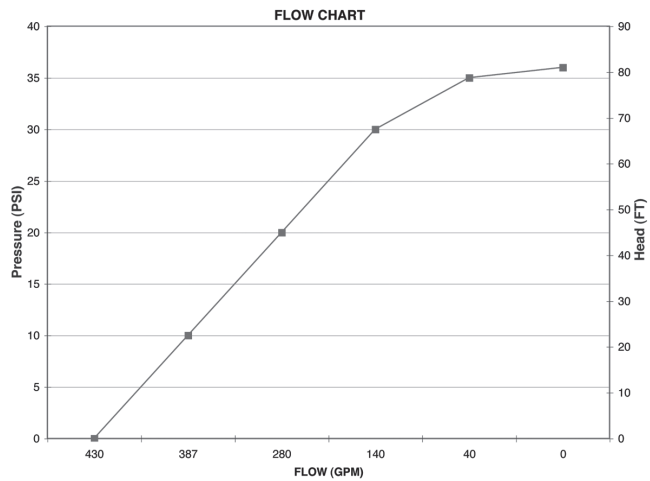

FLOW CHART FOR 333PIH13 & 333PBI

4" CAST IRON PUMPS

Port Size

Suction..... 4" NPT

Discharge 4" NPT

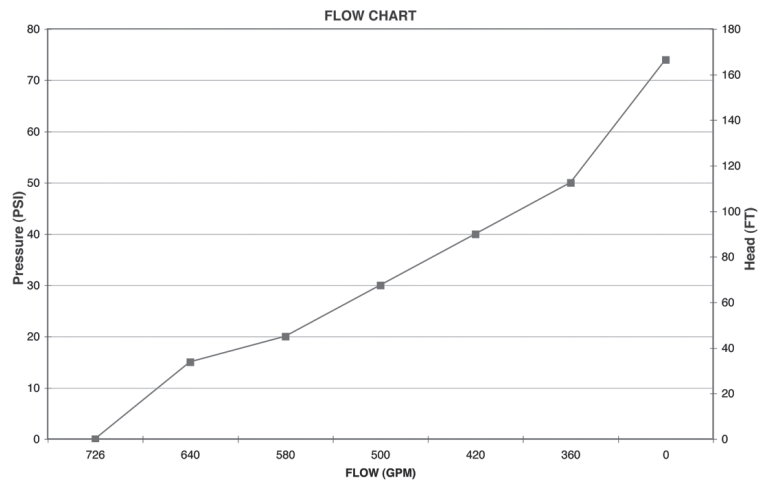

FLOW CHART FOR 444PIH24 & 444PBI

DISASSEMBLY INSTRUCTIONS:

NOTE:
If bracket shims have been installed from the factory, the same number of shims will need to be reinstalled

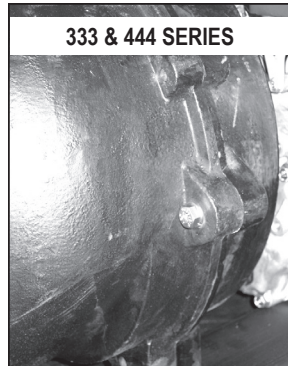
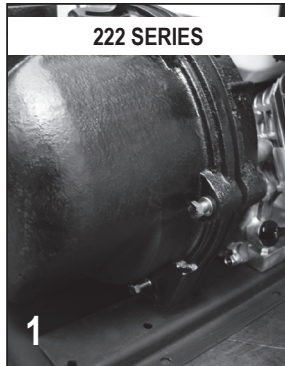

Remove the (6) bolts (222: 12715A, 333/444: V20011SS) and lock washers (222: V10118, 333/444: V20018) that hold the pump body assembly onto the rear bracket. Remove the body from the remaining pump assembly.

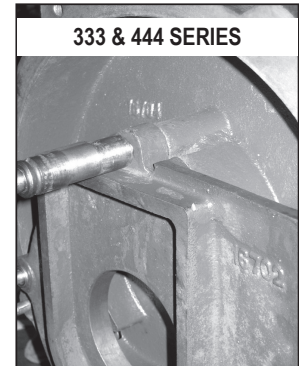
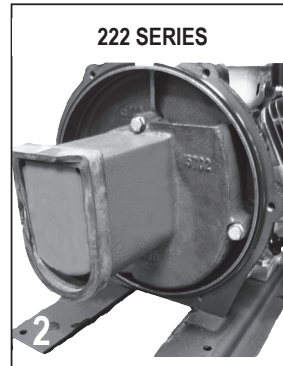

Remove the (3) bolts (222: 12715A, 333/444: V20011SS) and lock washers (222: V10118, 333/444: V20018) holding the volute to the rear bracket. Remove the volute (222: 15702, 333/444: 16702) from the remaining pump assembly. Replace checkvalve if needed.

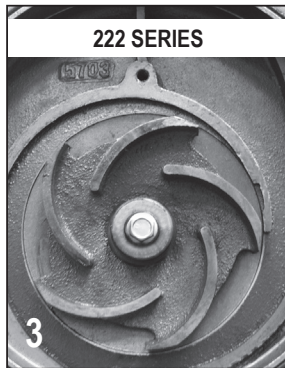

Remove the impeller bolt (222: 12765A, 333/444: 16765) from the impeller (222: 15772, 333/444: 16772). Remove the impeller bolt gasket from the impeller.

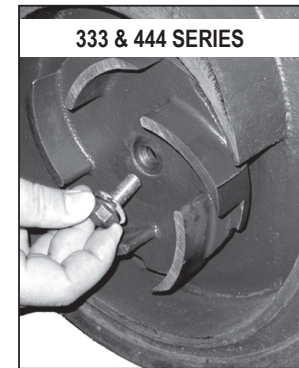
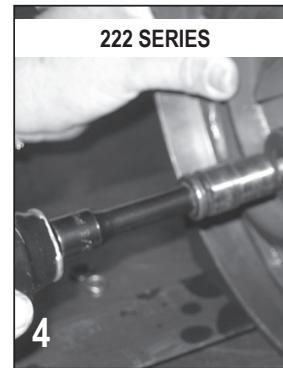

Screw the supplied (222: 7/16"-14, 333/444: 9/16"-12) hex head cap screw (16099) into the threaded hole in the impeller. As it tightens, the impeller will pull off the shaft. Remove the hex head cap screw once the impeller is removed. If reusing the pump impeller, remove the primary ring of the seal (222: 12733V, 333/444: 16713) and the impeller key (222: 12902A, 333/444: 16901).

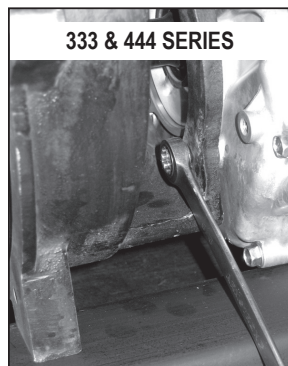
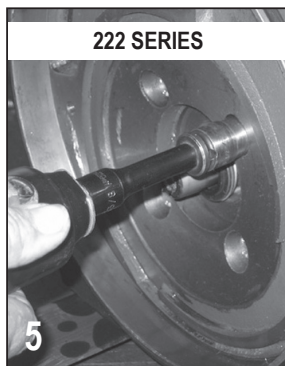

Remove the (4) bolts (222: 12715A, 333/444: 18027) and lock washers (222: 12901, 333/444: V20018) that hold the rear bracket to the drive unit. With the 4 bolts removed, the rear bracket can be removed from the drive unit. With the pump completely disassembled, clean all of the reusable parts thoroughly removing any traces of gasket material with a scraper or wire brush. Remove any corrosion on the sealing surfaces of the pump components.



Remove the cup seal half from the rear bracket. This may be done by using a round object such as a socket and tapping it with a hammer as shown in the photo. If necessary, remove the inlet and outlet flanges, the flange gaskets by removal of the flange screws and lock washers.

ASSEMBLY INSTRUCTIONS:

TOOLS REQUIRED:

222: 5/16" Box End Wrench, 5/16", 13/16" & 5/8" Socket

333/444: 9/16" Box End Wrench, 9/16", 13/16" & 5/8" Socket, Ratchet with 3" Extension, Gasket Scraper or Wire Brush, Loctite 242 and Loctite Gasket Adhesive #2

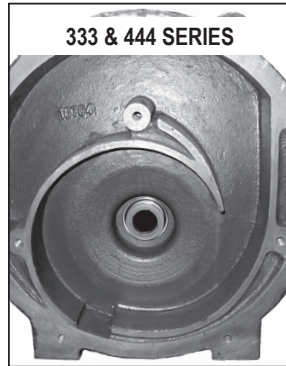
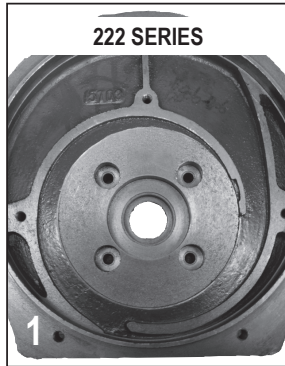

Place the seal O-ring behind the lip of the cup half of the seal. The cup half of the seal should now be installed into the rear bracket.

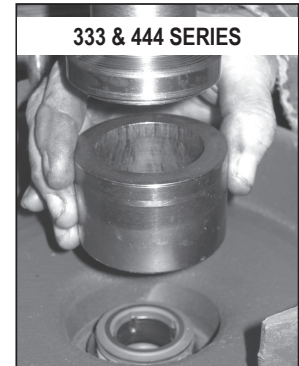
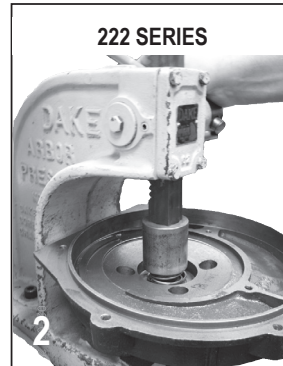

To install the cup half of the seal into the rear bracket, use a tool such as a 1" socket (222) or a 1 5/8" 12-point socket (333 / 444) to give even pressure on the metal flange of the seal housing during installation. The seal should be pressed into its bore. **Do not strike the seal with a sharp blow such as from a hammer. Do not press on the sealing face. Sealing faces are brittle and may fracture from impact.**

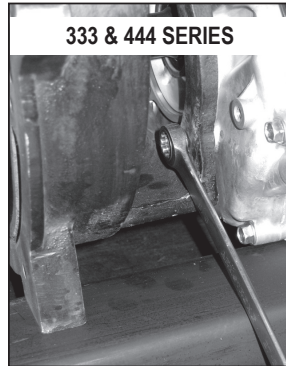
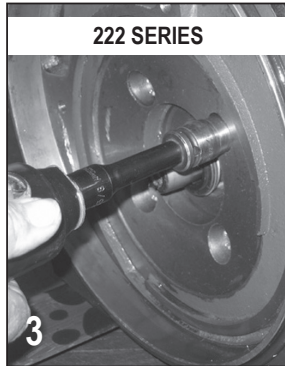

If shims were installed between the engine and rear bracket from the factory, install these shims now. Use the same number of shims as were originally in the pump from the factory. Install the rear bracket with the handle oriented toward the top of the drive unit.

222: Install 4 bolts, plain washers, and o-rings. Use LOCTITE® Threadlocker Blue 242® on these bolts due to the heat and vibration caused by the engine. Tighten to 12 ft-lb.

333/444: Install 4 bolts and lock washers. Use LOCTITE® Threadlocker Blue 242® on these bolts due to the heat and vibration caused by the engine. Tighten to 20 ft-lb.

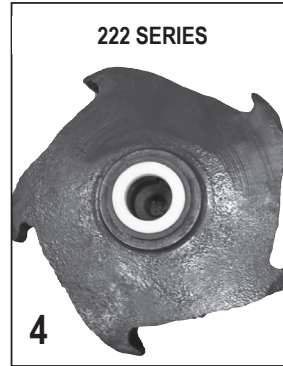

Install the primary ring seal half into the impeller. The seal half is pressed into the hub of the impeller by using both thumbs. The outside diameter of the primary ring may be sparingly coated with silicone to ease installation. The lapped or polished seal face must be installed face up.

Be absolutely sure that the primary ring seal half is bottomed out and installed squarely. If the installation is not square, seal wobble will occur leading to seal failure. Care must be used when handling the seal not to scratch or crack the seal surface. Sealing faces must be kept oil and contaminant free.

ASSEMBLY INSTRUCTIONS:

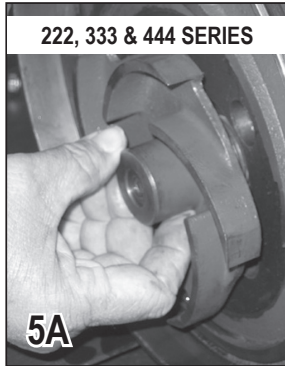

5A: The impeller is now ready to be slid onto the drive shaft unit. Be sure to align the impeller key with the keyway of the drive unit shaft.

5B: Secure the impeller to the drive unit shaft with the impeller boltgasket or O-ring and the impeller bolt. Tighten the impeller bolt to 12 ft-lb (222) or 45 ft-lb (333 / 444). The impeller bolt will pull the impeller into its final position on the drive unit output shaft.

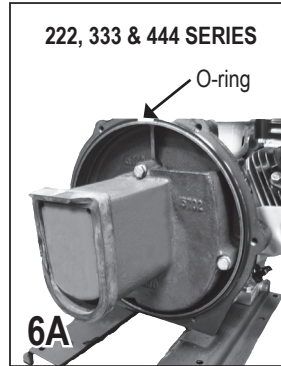
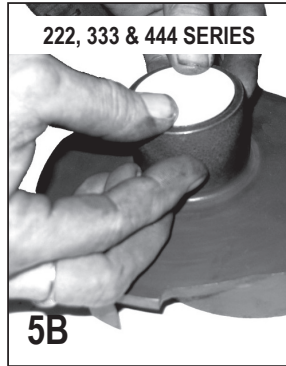

6A: Place the main pump body O-ring on the outside flange of the rear bracket.

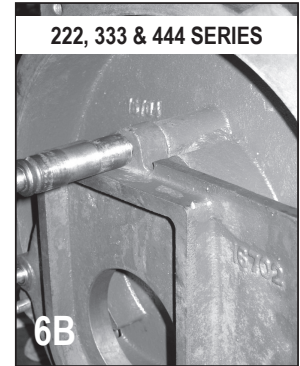

6B: Install the volute onto the rear bracket using 3 bolts and lock washers. Tighten the bolts to 12 ft-lb (222) or 20 ft-lb (333 / 444). We strongly recommend using LOCTITE® Threadlocker Blue 242® on these bolts due to the heat and vibration caused by the engine. There should be 0.080" to 0.100" clearance between the impeller face and the volute face. If the minimum clearance is not achieved, a shim will have to be installed between the rear bracket and the drive unit to achieve the proper clearance. If clearance is greater than the maximum, a shim will have to be installed in the impeller bore to achieve the proper clearance.

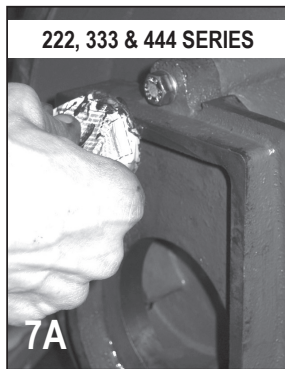

7A: Install the volute gasket as shown on the volute. We strongly recommend a light coating of gasket sealant, such as LOCTITE® Gasket Sealant #2, be applied between the gasket and the volute. The gasket sealant will ensure a good seal between the gasket and the mating cast iron parts. This seal is critical to having the pump prime well.

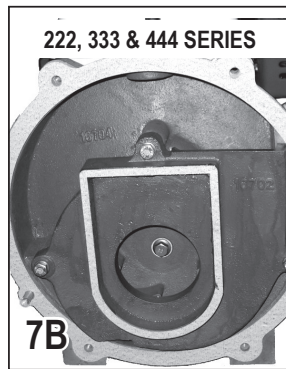

7B: Place the main pump body gasket on the outside flange of the rear bracket. The gasket should be aligned with and placed over the two dowel pins on the rear bracket. The gasket may be lubricated with ChapStick® or petroleum jelly. Lubricating the gasket in this manner will help it not to stick to the cast iron parts it is sealing against.



Install the pump body onto the rear bracket aligning the pump body with the dowel pins on the rear bracket. Secure the pump body to the rear bracket with six bolts and lock washers. Tighten the bolts to 12 ft-lb (222) or 20 ft-lb (333 / 444).

Pump is ready for operation.

TROUBLESHOOTING GUIDE:

1. GAS ENGINE WILL NOT START.

- a. Verify that there is no external damage to the engine.
- b. Verify that engine has the manufacturer's recommended amount and grade of oil in the engine.
- c. Verify that the engine gas tank has been filled with a minimum of 87 octane unleaded gasoline. Verify that the gasoline is fresh and clean.
- d. Verify that the spark plug wires are properly connected to the spark plugs.
- e. Verify that the battery cables are tight and properly connected to both the battery and engine.
- f. Verify that the battery is fully charged and in good condition.
- g. Review starting procedures and/or trouble-shooting guide in engine owners manual.
- h. Contact the engine manufacturer for warranty assistance and repair information.

Honda®: 800-426-7701 | www.honda.com

Briggs and Stratton®: 414-259-5262 | www.briggsandstratton.com

2. PUMP WILL NOT PRIME.

- a. Verify that the pump is filled with fluid prior to start up via the fill hole located on the top of the pump.
- b. Verify that the fluid is not being lifted more than 15 vertical feet.
- c. Verify that there are no kinks in the suction line.
- d. Verify that the pump inlet or suction line is not clogged.
- e. Verify that the suction line does not have any vacuum leaks at any of the connections.
- f. Verify that the pump is operating at a minimum of 3450 RPM for lifting and self-priming applications. Banjo pump will not prime while operating below 1750 RPM.
- g. Verify correct pump rotation if an electric motor or hydraulic motor is being used. A counter clockwise rotation (right hand rotation) is required from the motor.
- h. Verify that the impeller spacing is no more than 0.100".

3. PUMP LOOSES PRIME DURING OPERATION.

- a. See 2B above.
- b. See 2C above.
- c. Verify that the pump inlet or suction line is not clogged.
- d. Verify that the suction line does not have any vacuum leaks at any of the connections.
- e. Verify that the pump is operating at a minimum of 3450 RPM for lifting and self-priming applications. Banjo pump will not prime while operating below 1750 RPM.

4. ENGINE RUNS BUT PUMP DOES NOT TRANSFER LIQUID.

- a. Verify that the pump is operating at a minimum of 1750 RPM. Banjo pumps may not operate below this RPM.
- b. Verify correct pump rotation if an electric motor or hydraulic motor is being used. A counter clockwise rotation (right hand rotation) is required from the motor.
- c. Verify that the impeller spacing is no more than 0.100".
- d. Verify that the impeller is secured to the engine shaft with a shaft key. This verification can be done by turning the impeller (via the impeller bolt) on the pump by using a 5/8" socket attached to a 6" extension. If the impeller turns without spinning drive unit impeller, the shaft key is broken or missing. Replace shaft key.
- e. Verify that the customer does not have any kinks in the suction or discharge lines.
- f. Verify that the pump inlet, outlet, suction line or discharge line is not (partially) blocked.
- g. Verify all plumbing system valves are open.

(Continued on next page)

5. MOTOR RUNS BUT PUMP DOES NOT PERFORM ADEQUATELY.

- a. Verify that the pump is operating at a minimum of 1750 RPM. Banjo pumps may not operate below this RPM.
- b. Verify correct pump rotation if an electric motor or hydraulic motor is being used. A counter clockwise rotation (right hand rotation) is required from the motor.
- c. Verify that the impeller spacing is no more than 0.100".
- d. Verify that the impeller is secured to the engine shaft with a shaft key. This verification can be done by turning the impeller (via the impeller bolt) on the pump by using a 5/8" socket attached to a 6" extension. If the impeller turns without spinning drive unit impeller, the shaft key is broken or missing. Replace shaft key.
- e. Verify that the customer does not have any kinks in the suction or discharge lines.
- f. Verify that the pump inlet, outlet, suction line or discharge line is not (partially) blocked.
- g. Verify all plumbing system valves are open.

6. ENGINE BOGS DOWN DURING PUMP OPERATION / ELECTRIC MOTOR TRIPS CIRCUIT BREAKER DURING START UP OR OPERATION.

- a. Verify that the customer does not have any kinks in the suction or discharge lines.
- b. Verify that the pump inlet, outlet, suction line or discharge line is not (partially) blocked.
- c. Verify that the impeller spacing is no less than .080". The impeller should not be touching the wear plate/volute.
- d. Verify the weight of fluid being transferred. Make sure that the drive unit is properly sized for the pump and its application.

7. GRINDING, TICKING OR WHIRRING SOUND DURING PUMP OPERATION THAT IS UNUSUAL.

- a. Verify that the impeller bolt has not loosened, letting the impeller pull itself into the volute. The impeller spacing should be no less than .080". The impeller should not be touching the wear plate/volute.
- b. Verify that outside diameter is not hitting the pump housing or volute. Slowly rotate the pump several times by hand. If you can feel the pump dragging on the housing or volute or hear a scraping sound, the impeller may be hitting the pump body or volute. The impeller can be removed from the pump and filed down or trimmed down slightly on a lathe.
- c. Remove the pump housing and inspect for internal debris such as rocks, sticks or other foreign material stuck inside of pump. With the pump housing and volute removed, you can then inspect the impeller face and outside diameter for signs of contact between the impeller and other pump components.

8. PUMP/ENGINE RUNS TEMPORARILY, THEN STOPS. THE PUMP/ENGINE WILL NOT RESTART.

- a. Verify that there is no external damage to the engine.
- b. Verify that engine has the manufacturer's recommended amount and grade of oil in the engine.
- c. Verify that the engine gas tank has been filled with a minimum of 87 octane unleaded gasoline. Verify that the gasoline is fresh and clean.
- d. Verify that the spark plug wires are properly connected to the spark plugs.
- e. Verify that the impeller bolt has not loosened, letting the impeller pull itself into the volute. The impeller spacing should be no less than .080". The impeller should not be touching the wear plate/volute.

FUEL SYSTEM

Fuel Tank Position

The fuel tank must be installed so that its maximum gasoline level is within 50 cm (19.5 in) above or below the carburetor gasoline level.

Fuel Line

Use a low permeation fuel line (displaying an Executive Order number) rated for use with gasoline. The fuel line should have an inside dimension of 5.5 mm (0.22 in). Keep the fuel line as short as possible. Install the fuel line so it will not rest against any sharp objects or make sharp bends that can restrict the flow of fuel. If the fuel line passes through an enclosure wall, protect the line with a rubber grommet. Secure the fuel line with the appropriate clamping mechanism.

Route the fuel line away from hot engine and exhaust system components and away from electrical wiring. Secure the fuel line to prevent sagging and bending.

Fuel Valve

Install the fuel valve so it is easily accessible. Install the fuel valve at the outlet of the fuel tank and use an easily read label to indicate valve location and operation. If under the fuel tank is not the ideal location, securely install the fuel valve in-line with the fuel tube in a cool location, so that engine heat cannot cause vapor lock.

Fuel Pump

A fuel pump should be selected that provides an operating pressure of 0.1 kgf/cm² (1.4 psi) and delivers 15 liters/hr (4.0 US gal/hr). The carburetor inlet float valve has a closing pressure of 0.2 kgf/cm² (2.8 psi). If a secondary fuel pump is used, its operating pressure must not exceed the standard fuel pump's operating pressure (to prevent carburetor flooding).

Fuel Tank Filter Installation

It is recommended that a fuel tank strainer with a mesh rating of #80 be installed at the fuel tank inlet to catch debris when refueling. It is also recommended that a fuel tank sump be provided at the fuel tank outlet to reduce the chance of contaminants entering the fuel system.

Fuel-cut Solenoid

The fuel-cut solenoid on the carburetor takes power from the battery and there is continuity in the solenoid when the engine is running. Removing the battery when the engine is running will cause the engine to stop.

CONTROLS

Engine Switch

Use a three-position engine switch with continuity between its terminals as shown.

Wire Color Switch Position	IGN (BI)	GND (G)	BAT (W)	LO (BI/Y)	ST (BI/W)
OFF					
ON	○ — ○	○ — ○	○ — ○	○ — ○	
START	○ — ○	○ — ○	○ — ○	○ — ○	○ — ○

EVAPORATIVE EMISSIONS (CARB TIER 3)

The OEM is responsible for meeting the CARB EVAP emissions regulations for products sold in California. This regulation concerns evaporative emissions from the fuel system. See the *Emission Regulation Guide* for additional details.

Shown below is a simplified overview of required components.

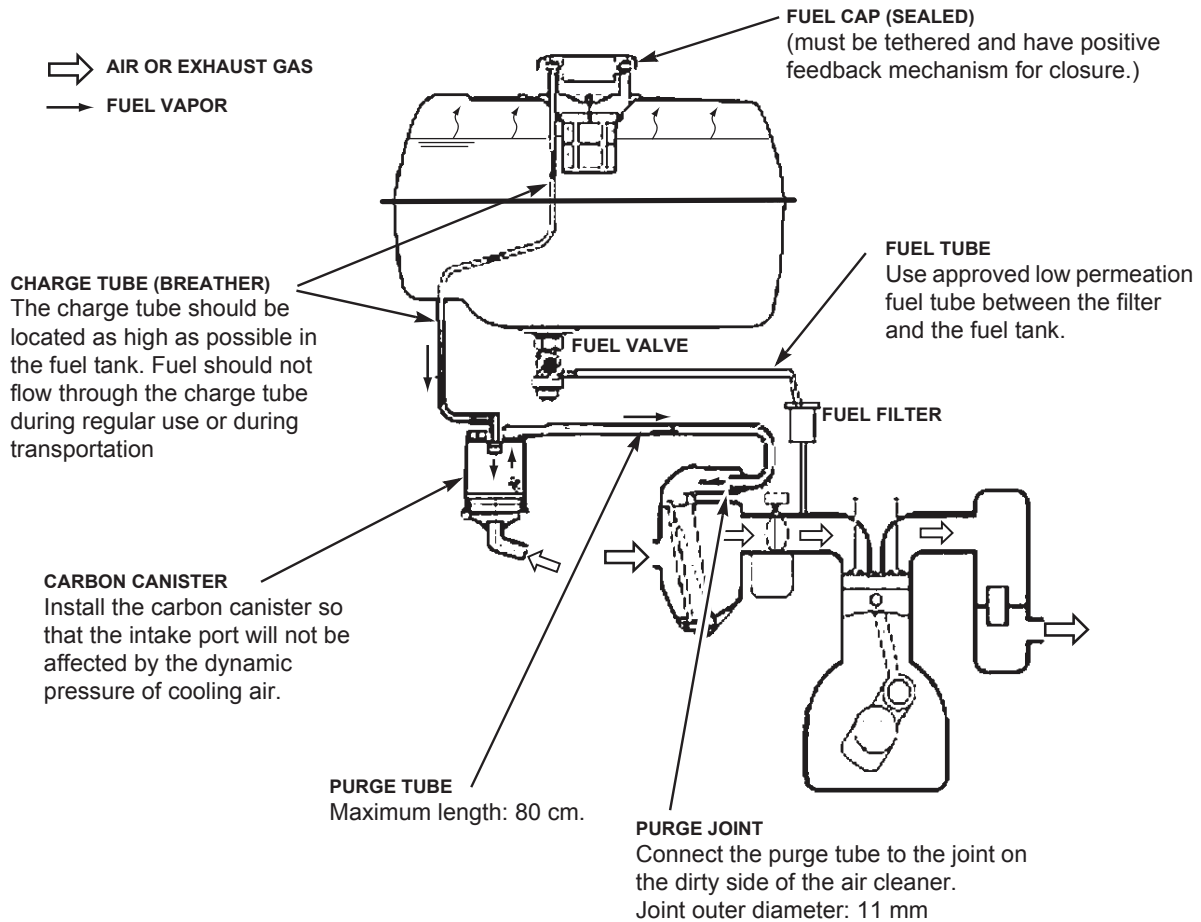

Additional information regarding manufacturers of CARB certified fuel system components can be found at:
<http://www.arb.ca.gov/msprog/offroad/sore/sorecomponent/sorecomponent.htm#>.

Please see banjocorp.com for more information



BANJO CORPORATION

A Unit of IDEX Corporation
 150 Banjo Drive
 Crawfordsville, IN 47933 U.S.A.
 Telephone: (765) 362-7367
 Tech Sales: (888) 705-7020
 Fax: (765) 362-0744
banjocorp.com

