

Parts List			
ITEM	QTY	PART NUMBER	DESCRIPTION
1	1	CE050D	CE DECAL
2	1	LS050-B	1/2" LINE STRAINER BODY
3	1	LS075-C1	3/4" LINE STRAINER CAP
3-1	1	12723	1/4" PIPE PLUG
3-2	1	12724	#14 O-RING
3-3	1	LS075XC1	1/2" & 3/4" LINE STRAINER CAP
4	1	LS075-G	#221 O-RING, EPDM
5	1	LS720	3/4" LS SCREEN - 20 MESH
6	1	LST1225D	225 PSI DECAL

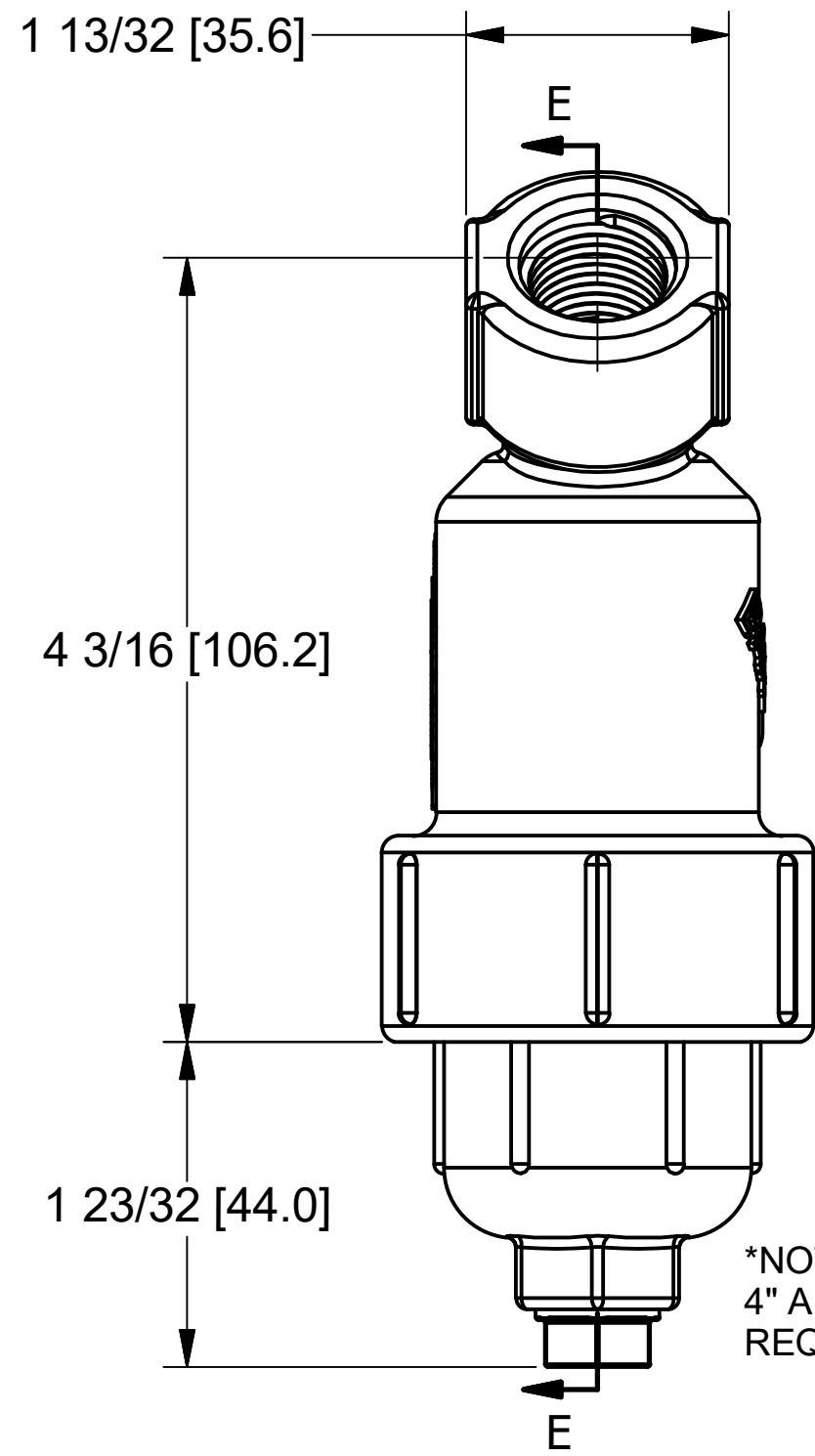

*NOTE:
4" ADDITIONAL CLEARANCE
REQ'D FOR SCREEN REMOVAL.

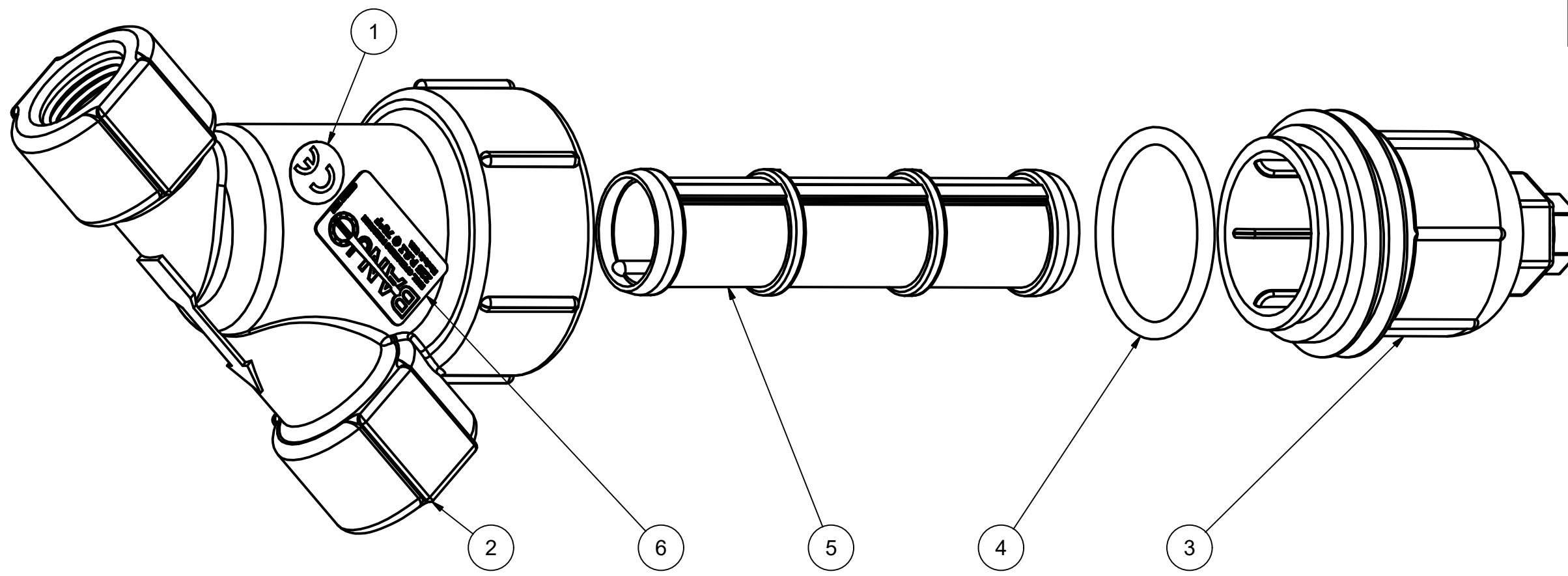
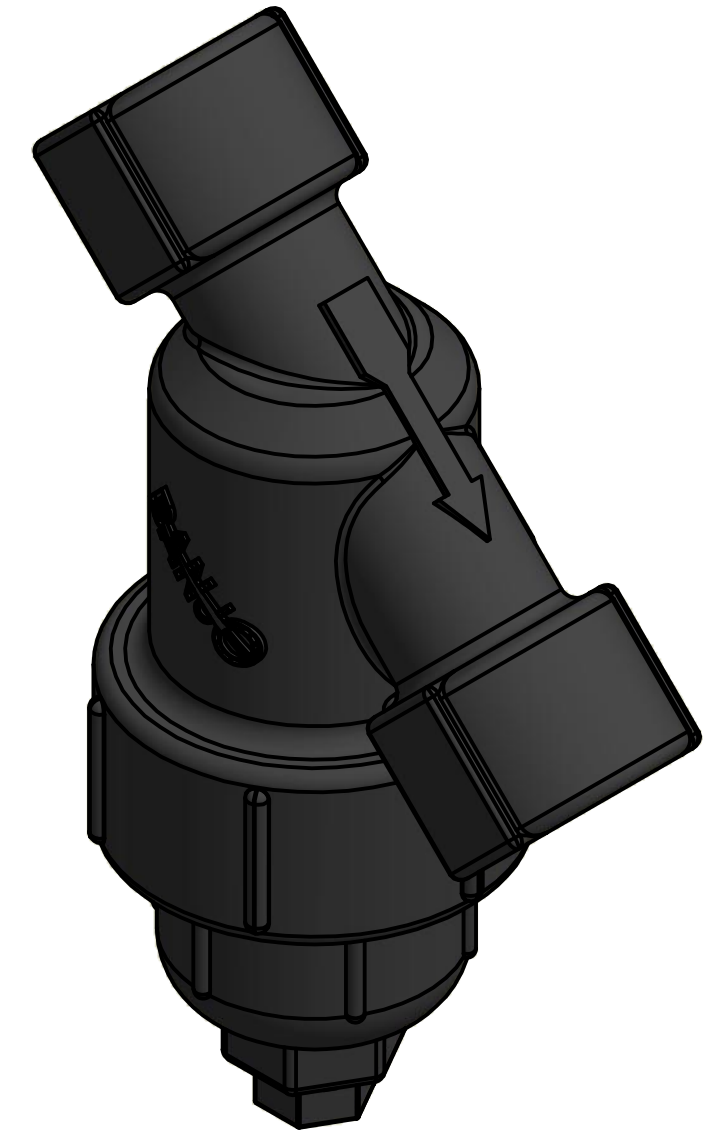
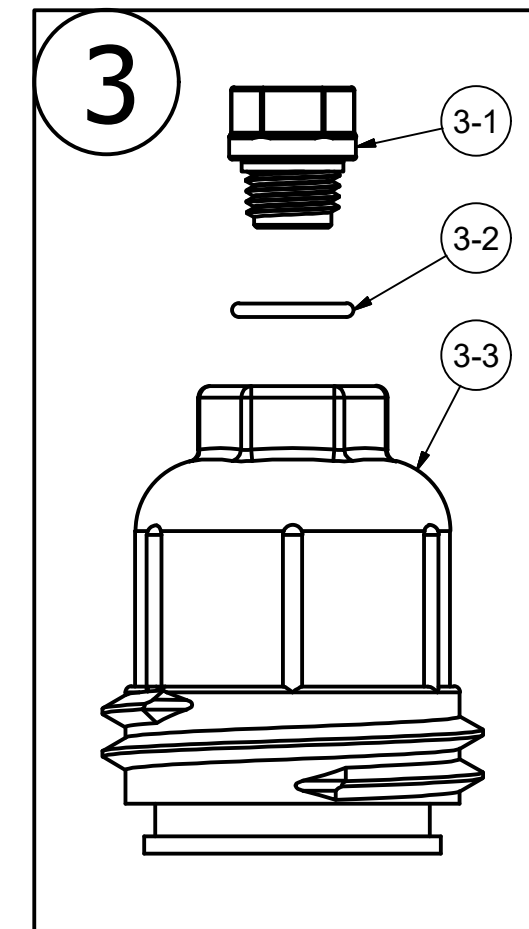
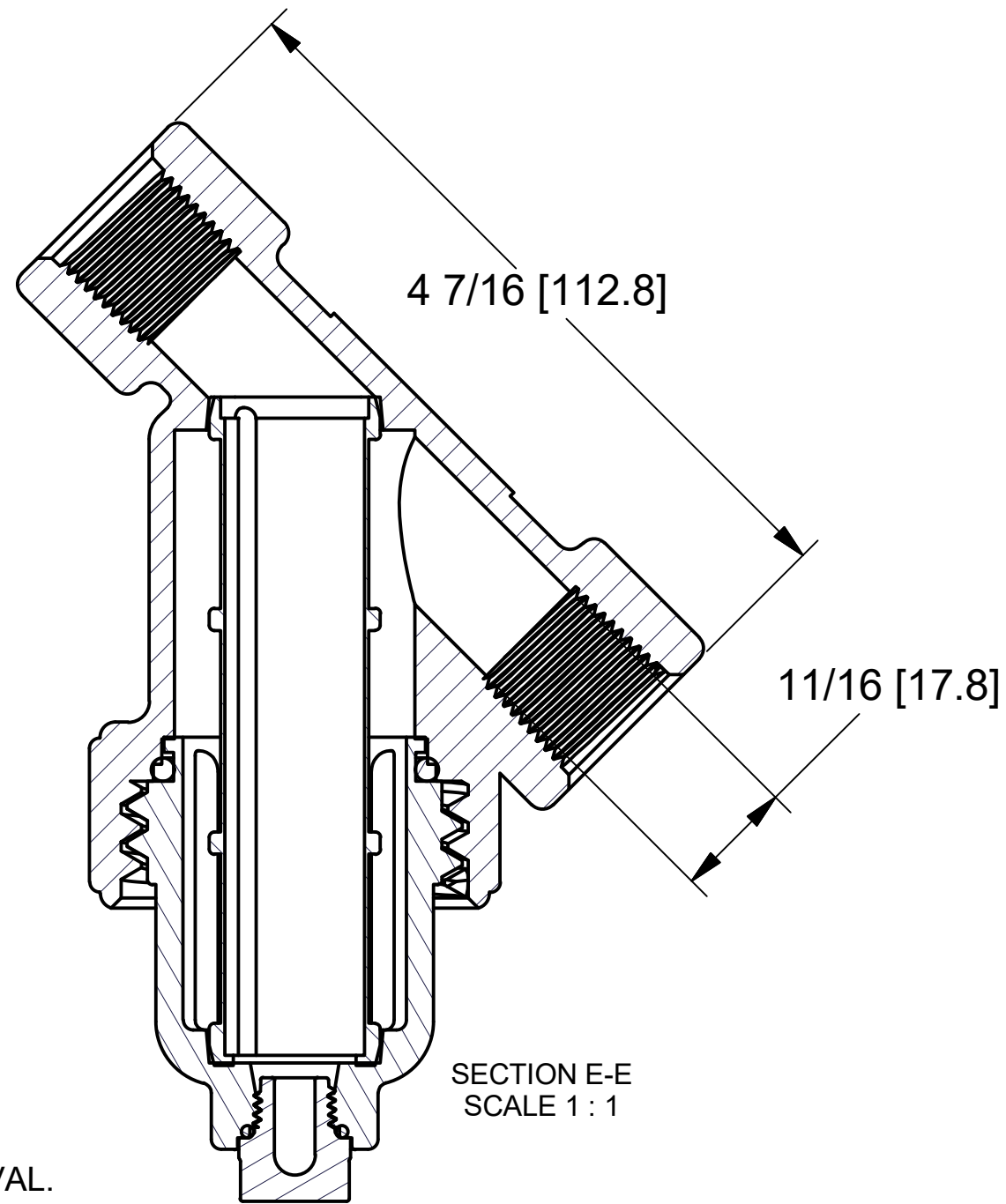

THIS DRAWING AND ALL INFORMATION CONTAINED THEREON ARE THE EXCLUSIVE PROPERTY OF BANJO CORPORATION.

UNLESS SPECIFICALLY NOTED, THIS DRAWING AND ITEMS SHOWN ON THIS DRAWING ARE SUBJECT TO CHANGE AT ANY TIME.

BANJO CORPORATION

BANJO CORPORATION
150 BANJO DRIVE, CRAWFORDSVILLE, IN 47933
WEB SITE: WWW.BANJOCORP.COM
E-MAIL: BANJOSALES@IDEXCORP.COM

DESCRIPTION
1/2" LINE STRAINER, 20 MESH

PART NUMBER
LS050-20