

Parts List			
ITEM	QTY	PART NUMBER	DESCRIPTION
1	1	LS150-C	LS CAP ASSY
2	1	LS150-G	#339 O-RING
3	1	LS206	2" LS SCREEN - 6 MESH
4	1	LST225D	DECAL (N/S)
5	1	MLS200B	2" LINE STRAINER BODY

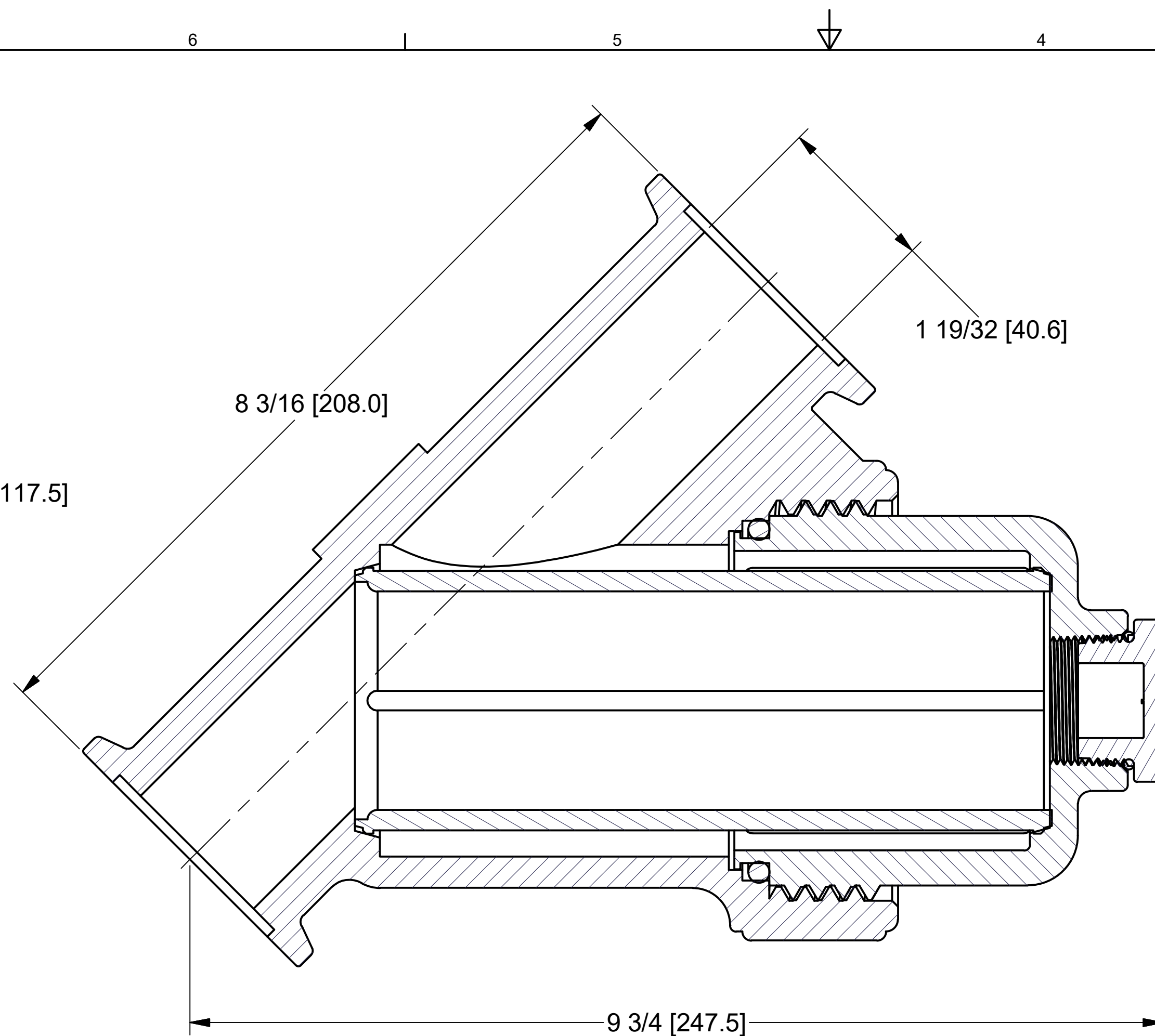

SECTION A-A
SCALE 1 : 1

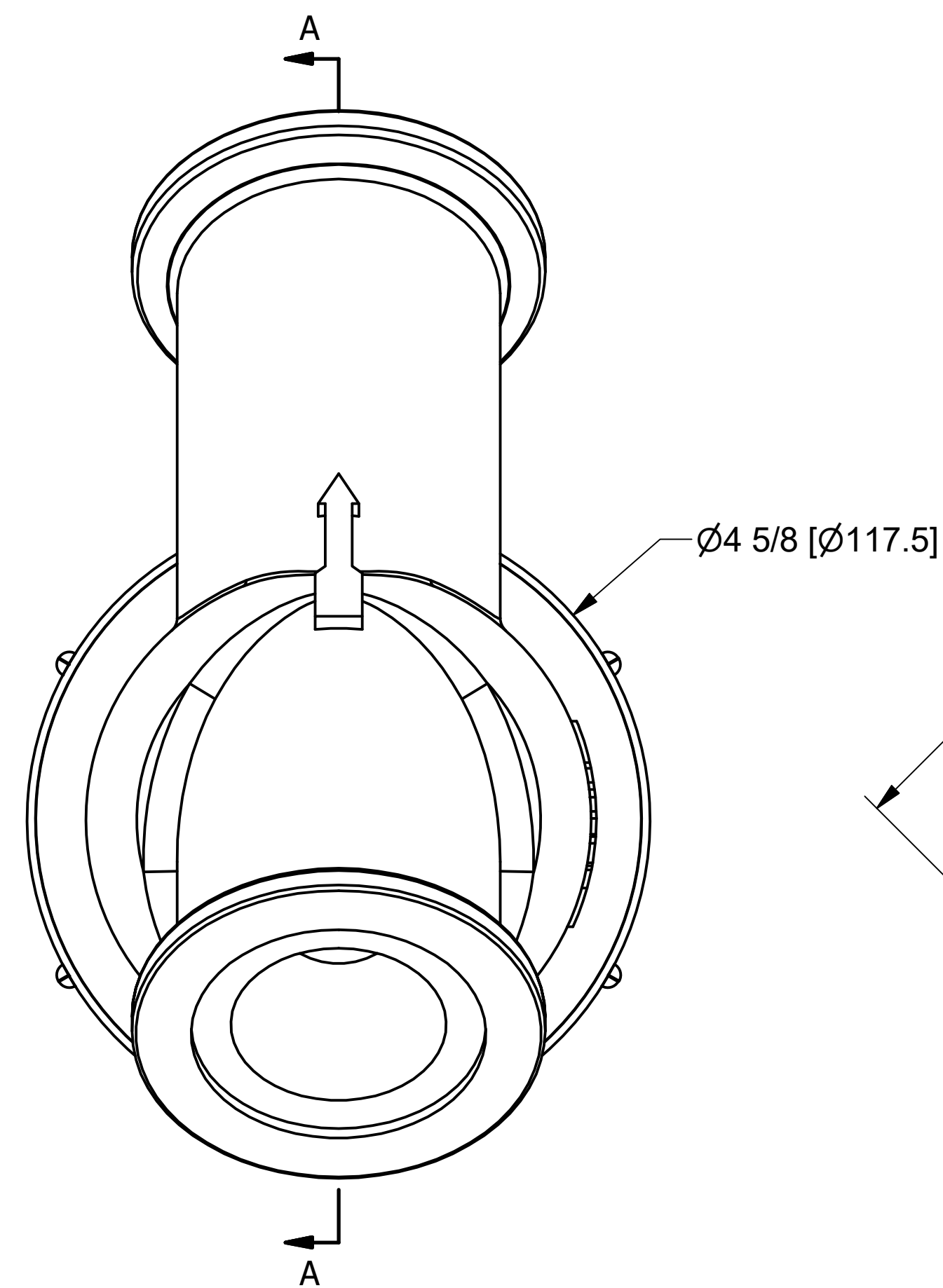
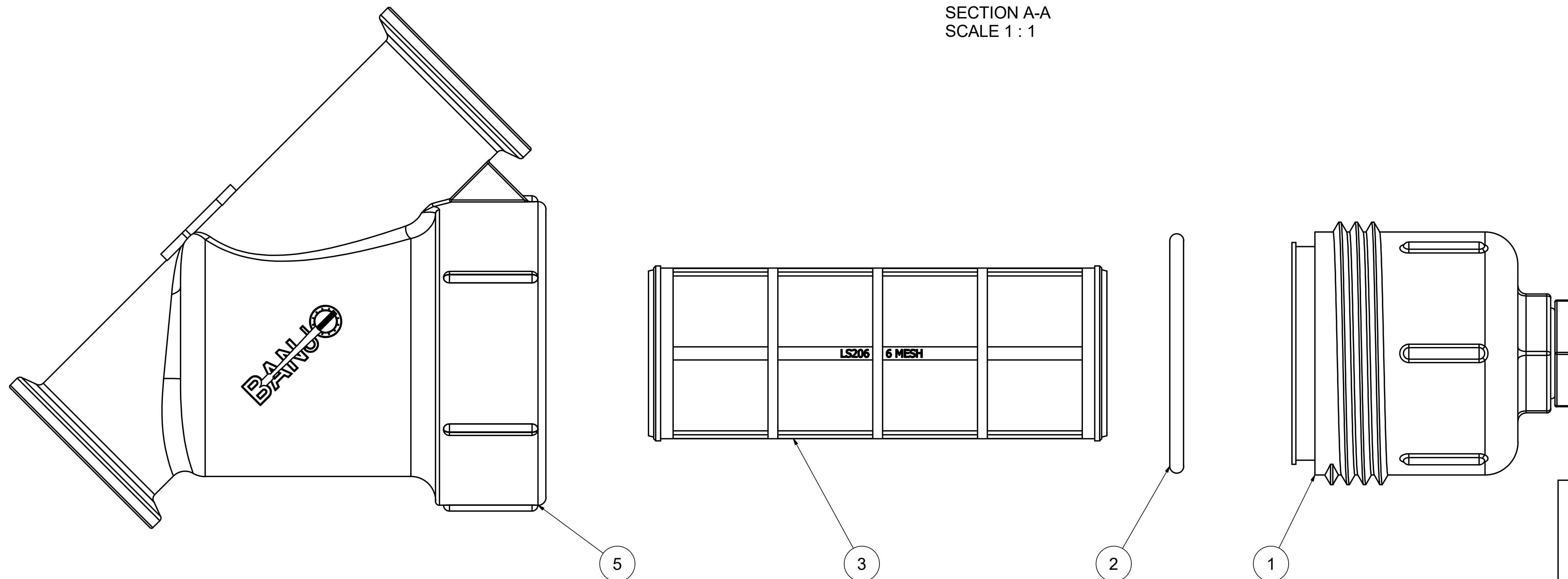

THIS DRAWING AND ALL INFORMATION CONTAINED THEREON ARE THE EXCLUSIVE PROPERTY OF BANJO CORPORATION.

UNLESS SPECIFICALLY NOTED, THIS DRAWING AND ITEMS SHOWN ON THIS DRAWING ARE SUBJECT TO CHANGE AT ANY TIME.



BANJO CORPORATION
150 BANJO DRIVE, CRAWFORDSVILLE, IN 47933
WEB SITE: WWW.BANJO.CORP.COM
E-MAIL: BANJOSALES@IDEXCORP.COM

DESCRIPTION
2" MANIFOLD LINE STRAINER - 6 MESH SCREEN

PART NUMBER
MLS200-06