

Parts List			
ITEM	QTY	PART NUMBER	DESCRIPTION
1	1	LST100-B	3/4" & 1" T-STRAINER BOWL
2	1	LST100-G	#226 O-RING
3	1	LST180	1" LST SCREEN - 80 MESH
4	1	LST300D	DECAL (N/S)
5	1	MLST100-H	1" MANIFOLD T-STRAINER HEAD

*NOTE:
ADDITIONAL CLEARANCE REQ'D
FOR SCREEN REMOVAL: 5 3/4"

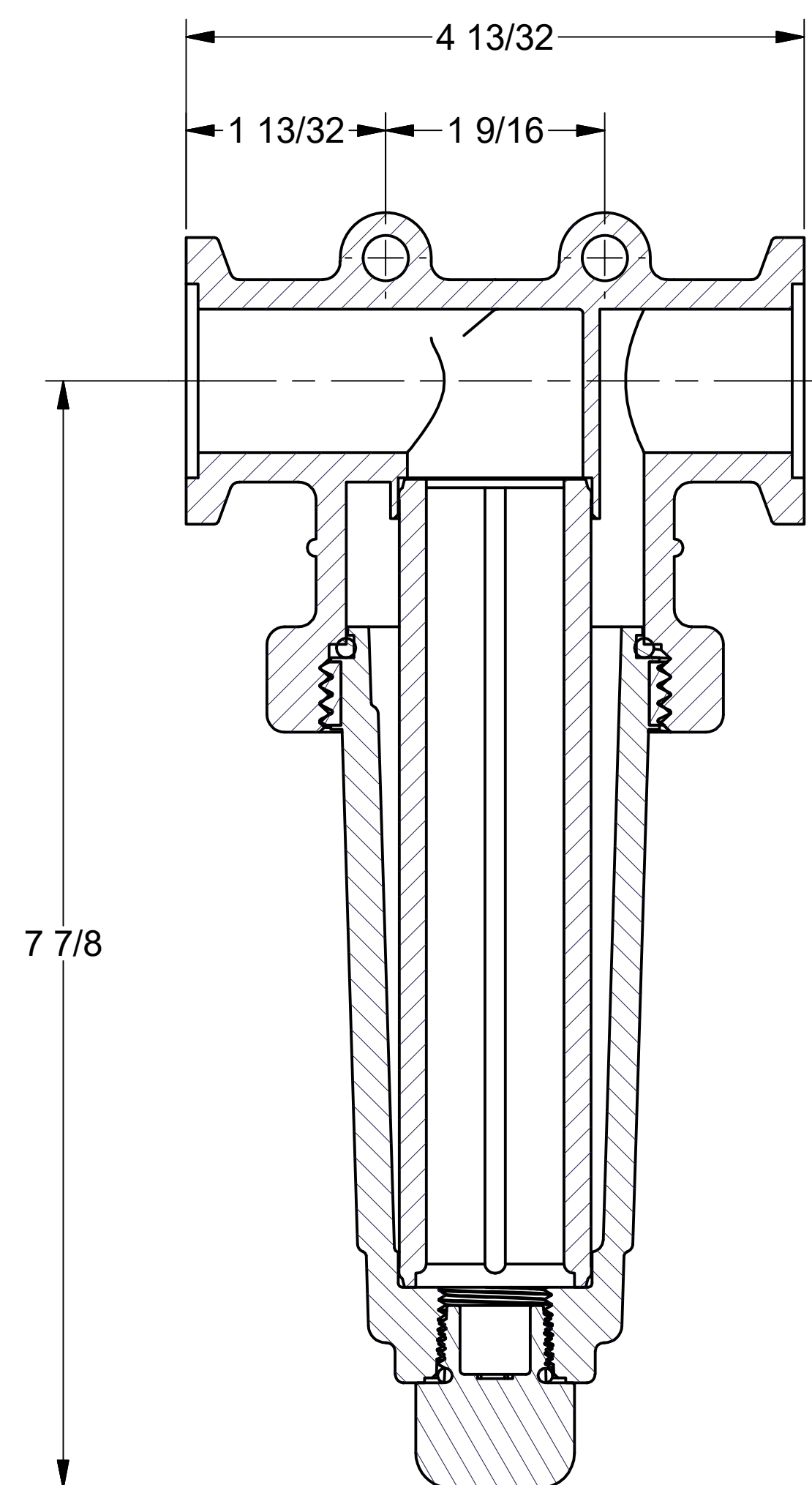
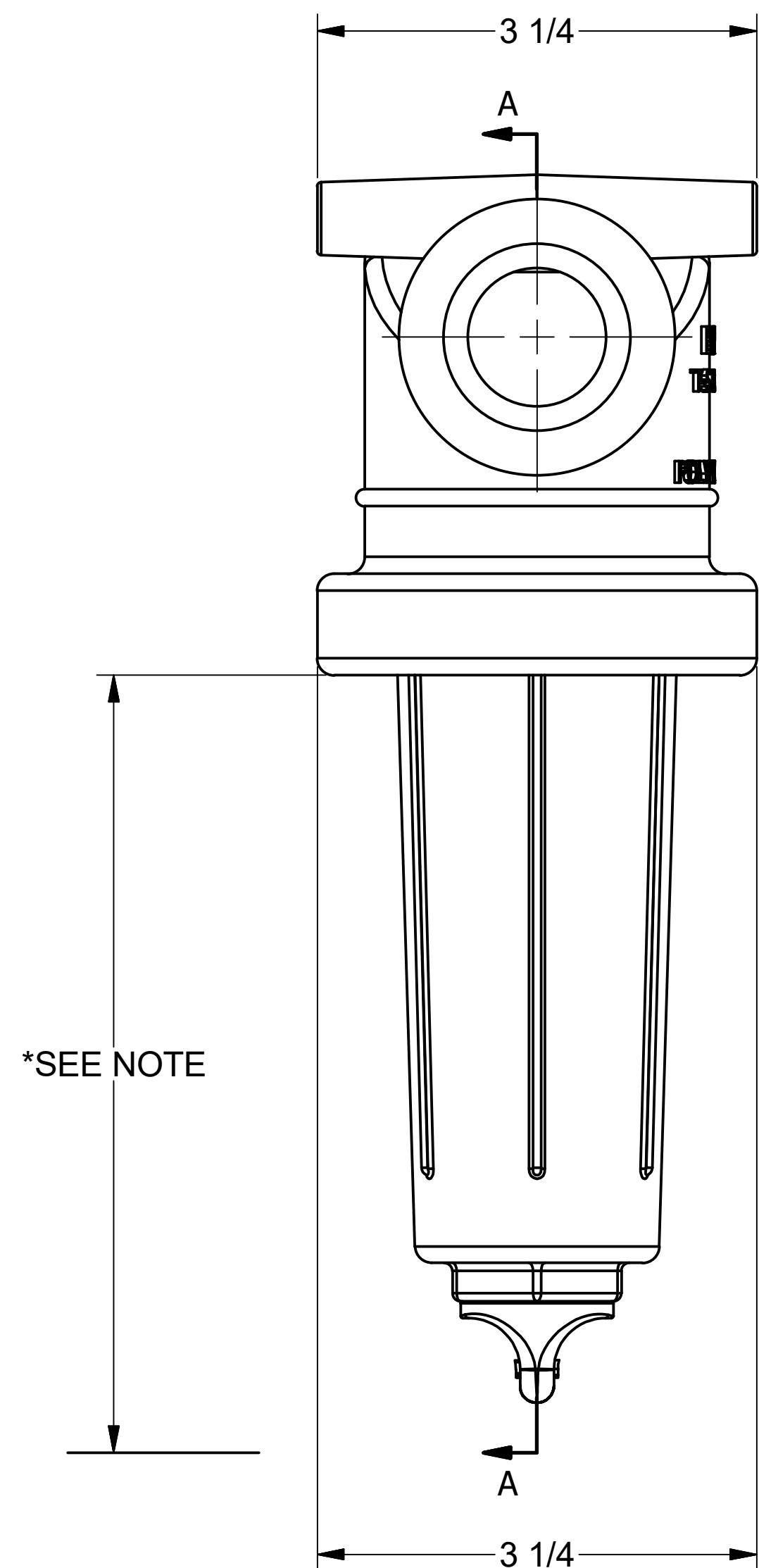
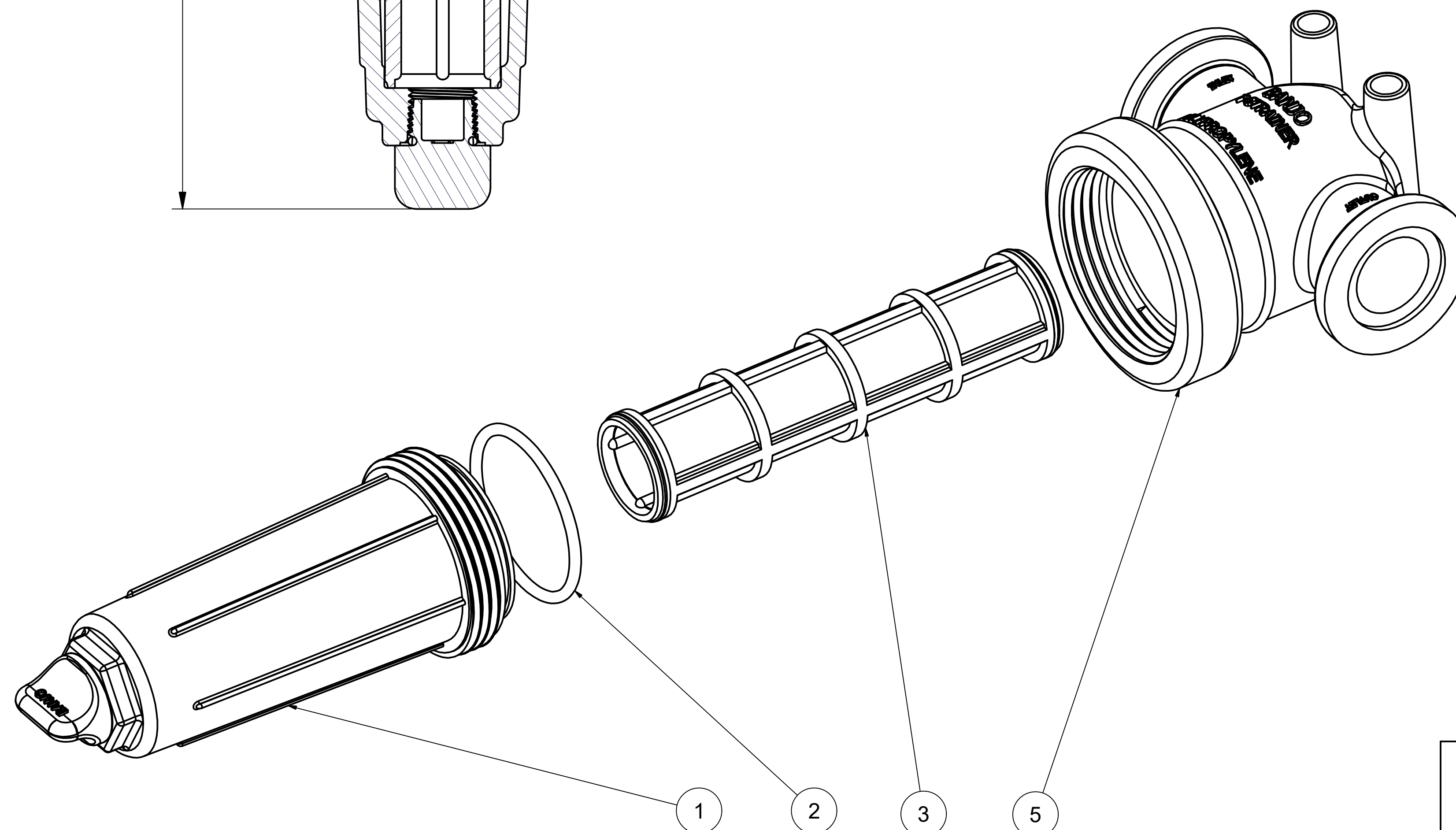

BANJO CORPORATION
150 BANJO DRIVE, CRAWFORDSVILLE, IN 47933
WEB SITE: WWW.BANJOCORP.COM
E-MAIL: BANJOSALES@IDEXCORP.COM

THIS DRAWING AND ALL INFORMATION CONTAINED THEREON ARE THE EXCLUSIVE PROPERTY OF BANJO CORPORATION.
UNLESS SPECIFICALLY NOTED, THIS DRAWING AND ITEMS SHOWN ON THIS DRAWING ARE SUBJECT TO CHANGE AT ANY TIME.

DESCRIPTION
1" MNFLD T-STRAINER W/ #80 MESH SCREEN
PART NUMBER
MLST100-80